

AMBIUS

ADLED6W85D-3T Q5070590



96mm Downlight

3000K

4000K

5000K

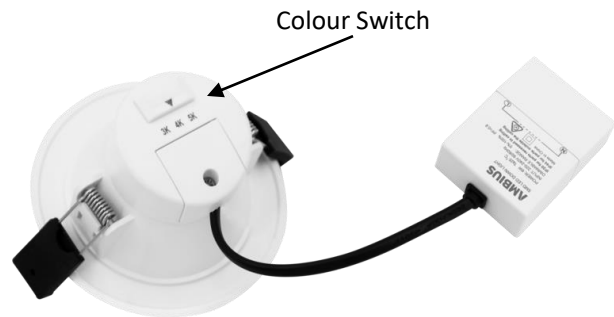

LUMINAIRE SPECIFICATION

Model: ADLED6W85D-3T

Lumens: 550

Dimmable: Yes

Cut-out: 75-85mm

IP Rating: IP44 parts outside the ceiling

Classification: IC-F

Wattage: 6W

Colour Temp: 3000K / 4000K / 5000K

Beam Angle: 120 degrees

Fascia: Flat

Estimated Lifespan: L80 50,000hrs

Input Voltage: 220-240Vac ~50Hz

Includes a driver that can be abutted and covered

Installation Diameter: Not less than 75mm (refer fascia size for maximum coverage for retrofit installations)

BEFORE STARTING PLEASE NOTE THE FOLLOWING:

- ***This product is intended to be fully covered by insulation material.***
- ***Insulation material as noted below can abut and cover this luminaire.***
- ***This product is suitable for use with building insulation that can safely be continually exposed to temperatures up to 90°C and must withstand a 30 s needle flame test carried out in accordance with AS/NZS 60695.11.5 with the flame applied to all surfaces of the sample. Glass fibre insulation is a suitable insulation for use abutting and covering this luminaire.***
- ***Loose fill insulation as defined in NZS 4246 is not permitted to abut or cover this luminaire.***
- ***This product is intended for indoor & outdoor use; however, the driver must always be installed indoors.***

Installation

BUILDING ELEMENT CLEARANCES FOR RECESSED LUMINAIRES

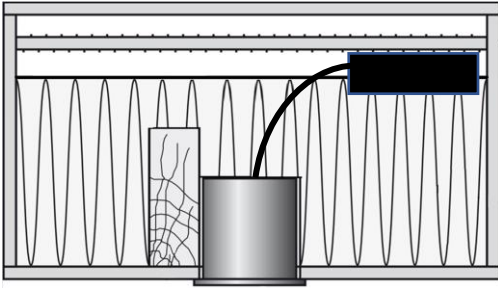

** Minimum insulation clearance (**MIC**) - from insulation to building element above

** Side clearance to building element (**SCB**) = **0mm**

** Height clearance to building element (**HCB**) = **0mm** from top of luminaire to building element above

** Driver above insulation

Downlights can be installed in timber ceilings and come into contact with normally flammable Building Material. (ie material having ignition temperature of at least 200deg).

CAUTION

Recessed luminaires and their auxiliary equipment may pose a risk of fire or damage to property if not installed and maintained correctly.

SAFETY NOTICE

If you have any doubts about your ability to conduct the wiring work safely or about the method of installing light fittings, please employ a licensed electrical worker to carry out the installation for you. Failure to wire incorrectly may result in electric shock injury or a fatality to yourself or a member of your family.

COLOUR CHANGE

This Downlight comes with Colour temperature options. 3000k, 4000k and 5000k. Select the desired colour prior to installation using the colour switch on the back of the light.

DIMMING

This LED down light can be used in conjunction with Universal, Trailing and Leading Dimmers.

It is the installers responsibility to ensure that the dimmer selected is compatible with the characteristics of the downlight.

INSTALLATION LOCATION

This type of IC-F recessed luminaire can be abutted and covered with thermal building insulation with a minimum temperature rating of 90°C.

INSTALLATION

CAUTION: ISOLATE (TURN OFF) MAINS SUPPLY BEFORE CONNECTING THE DOWNLIGHT.

1. Cut a hole min 75mm, max 85mm in diameter into the ceiling (It is prohibited to cut or Notch Joists, Beams, rafters and Ceiling Battens).
2. To wire: open the cover on the driver box to expose terminal block. Use a small flat head screwdriver to do this.
3. This product comes with push in quick connect terminals.
4. This product does not require an earth connection; however, we provide an earth loop terminal. Connect the power cable from the mains, into the 220V-240V input terminals (N, Neutral, Blue), (L, Live, Brown), (E, Earth LOOP, Green). Ensure that any connection made complies with New Zealand Electrical Wiring rules AS/NZS 3000. Connections should be secure.
5. Close the terminal cover and ensure it is firmly seated over the power input cable. The cover should clamp the supply cable to hold it securely in place, be careful not to over-tighten and damage the supply cable.
6. Lift springs, hold back and insert luminaire.
7. Ensure that any existing insulation material is in accordance with the specifications above.
8. Do not swap the LED Driver for any other model, it is specific to the integrated LED downlight as supplied.

Warranty

WARRANTY. 3 Years on Driver. 3 Years on Fitting .

- ✓ The Warranty for this fitting is from the date of purchase and against defects in the material and /or workmanship.
- ✓ This warranty is subject to the product being installed, wired, operated and used in accordance with the instructions and specifications.
- ✓ Any alterations or modifications made to the product without permission will void the warranty
- ✓ Particulars of any potential fault / defect must be notified within 28 days of any fault / defect being detected
- ✓ Ambius will at its discretion repair, replace or refund any product found to be defective.
- ✓ The cost of replacement or repair of a defective product is limited to the price of the product only.

PLEASE KEEP YOUR RECEIPT AS THIS WILL HELP VERIFY YOUR WARRANTY.

New Zealand

PO Box 100-707

N.S.M.C

Auckland

Phone +64 (0)9 917 4000

Phone 0800 232 633

info@cdb.co.nz

Australia

PO Box 574

South Morang

Victoria, 3752

Phone +61 (0)3 9365 5100

Phone 1300 465 324

info@cdbgoldair.com.au

(IMPORTANT: Please complete and retain this warranty card)

Name

Address

Place Of Purchase

Date Of Purchase

Name Of Product

Model Number

Attach a copy of the purchase receipt to this warranty card

AMBIUS

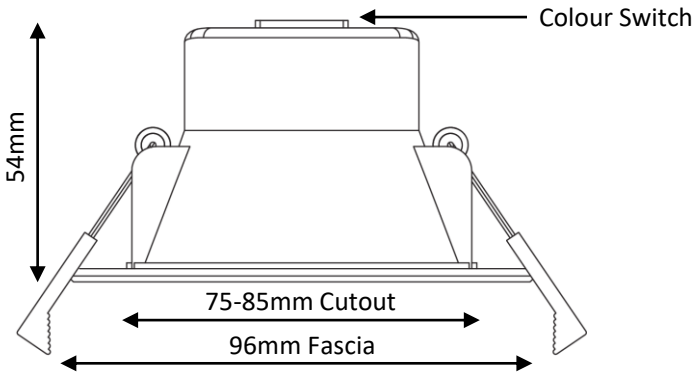

PHOTOMETRICS

— C0-C180 — C90-C270

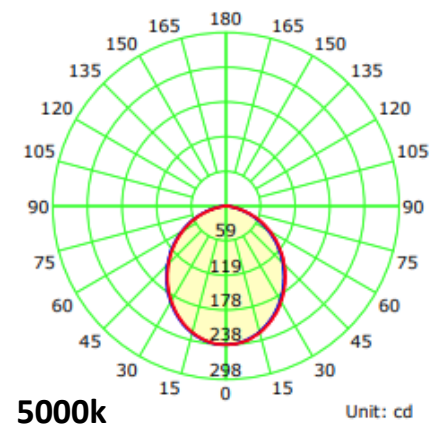
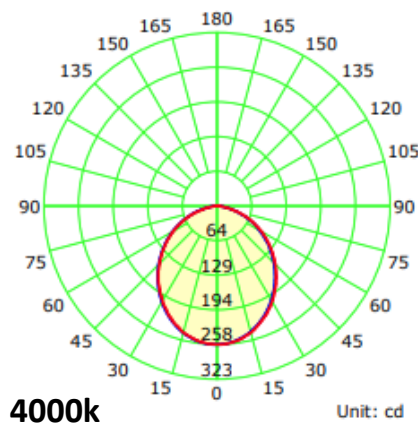
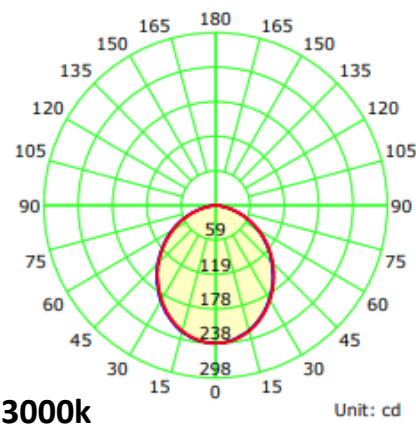

Other features available within the AMBIUS range

There is a product within the AMBIUS range to suit almost every application. New builds, retrofit, task, designer. We have you covered.



INTERCHANGEABLE FASCIAS
There are over 8 different fascia finishes available for various downlight models.

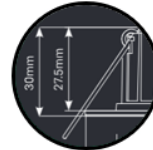

LOW PROFILE
Our range minimises heat sink height while maintaining light efficiency.



COLOUR TEMPERATURE
The range includes options in 3k/4k/5k/6k colour temperatures. Some models can be changed with the flick of a switch.



DUAL POWER
Featured on some products, 2 power settings and therefore 2 lumen outputs.



HIGH CRI
High CRI 90+ and for exceptionally high colour rendering CRI 96+.



PRE-WIRE
The Ambius range includes product with independent drivers, which facilitate a pre-wire option and/or alternative driver connection.



FIRE RATED
Where specification calls for a fire rated downlight the Ambius range also includes a fire rated product.



QUICK CONNECT
This is a feature on a number of downlights for quick and easy wiring.